

of potassium dihydrogen phosphate in place of *p*-nitrophenol as the acid catalyst, **10**<sub>S<sub>P</sub></sub> was converted to **14**<sub>S<sub>P</sub></sub>. In the latter case it was necessary to add water (25% v/v) to solubilize the phosphate and as a result, the product consisted of **14**<sub>S<sub>P</sub></sub> (>15:1 ratio of diastereomers) and the dianion **13** in a ratio of approximately 2:1.

**N**-(Methoxy(methyl)phosphinyl)-L-phenylalanine Methyl Ester (**15**)<sup>2</sup> by Base-Catalyzed Methanolysis of **9**. A solution of 10.3 mg (0.036 mmol) of (*S*<sub>P</sub>)-*N*-(methyl(methylthio)phosphinyl)-L-phenylalanine methyl ester (**9**<sub>S<sub>P</sub></sub>) in 1.75 mL of anhydrous methanol was stirred with 1.9 mg (0.014 mmol) of solid K<sub>2</sub>CO<sub>3</sub> at 21 °C for 38 h. After removal of the solvent at reduced pressure, the residue was partitioned between 2 mL of chloroform and 2 mL of water. The aqueous layer was extracted with another 2-mL portion of chloroform, and the combined organic extracts were dried (MgSO<sub>4</sub>) and concentrated under reduced pressure to give 8.8 mg (90% yield) of **15**<sub>R<sub>P</sub></sub> (4.2:1 ratio of diastereomers) as a white, crystalline solid, identical by <sup>1</sup>H NMR spectroscopy with a sample previously obtained by an alternate route (see preceding paper<sup>2</sup>). By a similar procedure, 10.9 mg (0.038 mmol) of **9**<sub>R<sub>P</sub></sub> produced 7.8 mg (76% yield) of **15**<sub>S<sub>P</sub></sub> (5.2:1 ratio of diastereomers) as a white, crystalline solid.

**Acknowledgment.** Support for this research was provided by a grant from the National Institutes of Health (CA-22747). We also express our gratitude to Dr. Diana J. Parsons for the use of her Osborne 1 computer to do the kinetic simulations.

**Registry No.** **1**, 84558-28-1; **2**, 84558-47-4; **3** (isomer 1), 84558-29-2; **3** (isomer 2), 84558-30-5; **4a**, 14410-07-2; **4b**, 84558-31-6; **5** (isomer 1), 84558-32-7; **5** (isomer 2), 84558-33-8; **6** (isomer 1), 80556-19-0; **6** (isomer 2), 80565-18-0; **7** (isomer 1), 84558-34-9; **7** (isomer 2), 84558-35-0; (**±**)-**8**, 36585-69-0; **8**<sup>S<sub>P</sub></sup>, (-)-**α**-phenylethylamine, 84558-36-1; **8**<sup>R<sub>P</sub></sup>, (-)-**α**-phenylethylamine, 13889-55-9; **9** (isomer 1), 84558-37-2; **9** (isomer 2), 84558-38-3; **10** (isomer 1), 84558-39-4; **10** (isomer 2), 84558-40-7; **11** (isomer 1), 84558-41-8; **11** (isomer 2), 84558-42-9; **12** (isomer 1), 84558-43-0; **12** (isomer 2), 84558-44-1; **13**, 84558-45-2; **14** (isomer 1), 84621-21-6; **14** (isomer 2), 84621-22-7; **15** (isomer 1), 84558-46-3; **15** (isomer 2), 84558-49-6; L-phenylalanine methyl ester, 2577-90-4; methylphosphonothioic dichloride, 676-98-2; 3-hydroxypropanenitrile, 109-78-4; L-phenylalanine methyl ester-HCl, 7524-50-7.

## Thermal Sigmatropic Rearrangements of Vinylallenes Leading to 11-*cis*-Retinoids and the Novel Properties of 9-*cis*,11-*cis*,13-*cis*-Retinal and 11-*cis*,13-*cis*-Retinal<sup>1</sup>

Christopher G. Knudsen,<sup>2</sup> Roshantha A. S. Chandraratna, Leslie P. Walkeapää, Yeshpal S. Chauhan, Stephen C. Carey, Thomas M. Cooper, Robert R. Birge, and William H. Okamura\*

Contribution from the Department of Chemistry, University of California, Riverside, California 92521. Received August 16, 1982

**Abstract:** The thermally induced [1,5] sigmatropic hydrogen shift of vinylallene **5** provided a route to highly hindered 11-*cis*-retinoids. The coupling of the hetero cuprate **14** with the propargyl benzoate **13b** gave the vinylallene **5**, which upon heating (69 °C, 2 h) gave three geometrically isomeric retinoids: 11-*cis* (**8**), 11-*cis*,13-*cis* (**9**), and 9-*cis*,11-*cis*,13-*cis* (**11**). The fourth possible geometric isomer, 9-*cis*,11-*cis* (**10**), was unstable to the conditions of thermolysis and underwent further electrocyclicizations to the tricyclic compound **22**. The thermal rearrangement of the 9,10-allene **5**, though highly specific for the formation of 11-*cis*-retinoids, exhibits no selectivity in the formation of the Δ<sup>9</sup> and Δ<sup>13</sup> double bonds. The highly hindered 11-*cis*,13-*cis*- and 9-*cis*,11-*cis*,13-*cis*-retinals, **9b** and **11b**, exhibit extraordinary electronic absorption spectra in that they exhibit their main maxima (302 nm) actually to the blue of the corresponding alcohols. The retinals **9b** and **11b** were very thermally unstable and underwent clean isomerization to 13-*cis*-retinal and 9-*cis*,13-*cis*-retinal, respectively.

### Introduction

After a brief hiatus, there has been a resurgence of chemical interest in the retinoids (vitamin A). This can be attributed to the recent renaissance of the vision field<sup>3</sup> and the emergence of retinoids as compounds of importance in the areas of energy transduction,<sup>4</sup> cancer prophylaxis,<sup>5</sup> and acne therapy.<sup>6</sup> The availability of the various geometric isomers of retinoids and

(1) (a) For a preliminary account of this work, see: Knudsen, C. G.; Carey, S. C.; Okamura, W. H. *J. Am. Chem. Soc.* **1980**, *102*, 6355. For related studies, see (b) Sueiras, J.; Okamura, W. H. *Ibid.* **1980**, *102*, 6255. (c) Chandraratna, R. A. S.; Okamura, W. H. *Ibid.* **1982**, *104*, 6114. (d) For a new preparation of **12**, see: Ruzziconi, R.; Schlosser, M. *Angew. Chem.* **1982**, *94*, 865.

(2) The major portion of this article was taken in part from the Ph.D. thesis submitted to the University of California, Riverside, by C. G. Knudsen (May 1980).

(3) Menger, E. L. *Acc. Chem. Res.* **1975**, *8*, 81, and accompanying articles. Birge, R. R. *Annu. Rev. Biophys. Bioeng.* **1981**, *10*, 315. Ottolenghi, M. *Adv. Photochem.* **1980**, *12*, 97.

(4) Stoeckenius, W. *Sci. Am.* **1975** (Nov), 38.

(5) Sporn, M. B. *Nutr. Rev.* **1977**, *35*, 65.

(6) (a) Peck, G. L.; Olsen, T. G.; Yoder, F. W.; Strauss, J. S.; Downing, D.; Pandya, M.; Butkus, D.; Arnan-Battandier, J. *N. Engl. J. Med.* **1979**, *300*, 329; (b) *Chem. Eng. News* **1979**, *57* (Feb 19), 6-7.

### Scheme I

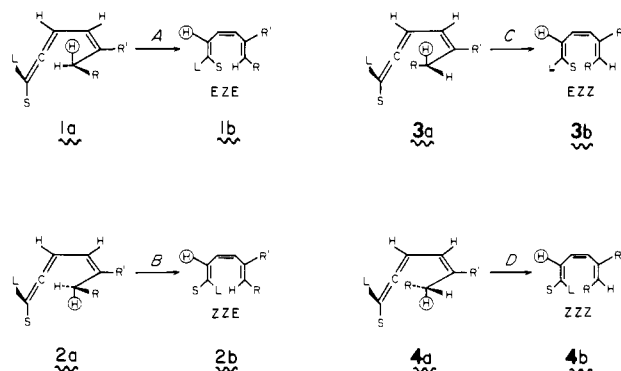

retinoid analogues in sufficient quantities for rigorous biological assay is crucial to the continued rapid progress in the retinoid field. In this light, the development of more efficient synthetic methods for preparing some of the difficult-to-obtain sterically hindered retinoids is highly desirable.

Our interest in the retinals stems from our desire to define the scope and limitations of [1,5] sigmatropic shifts of vinylallenes<sup>1,7,8</sup> for synthesizing (3*Z*)-1,3,5-hexatrienes such as shown in Scheme I. Assuming a concerted suprafacial process, the vinylallene is constrained to produce a 1,3,5-hexatriene possessing a central *Z* double bond. The geometries expected for the terminal double bonds are not easily predictable, and it is our intention to examine what factors influence the *Z* to *E* outcome of the latter. Accordingly, our efforts were directed toward synthesizing and studying the thermal behavior of the vinylallene **5a**,<sup>1a</sup> which seemed

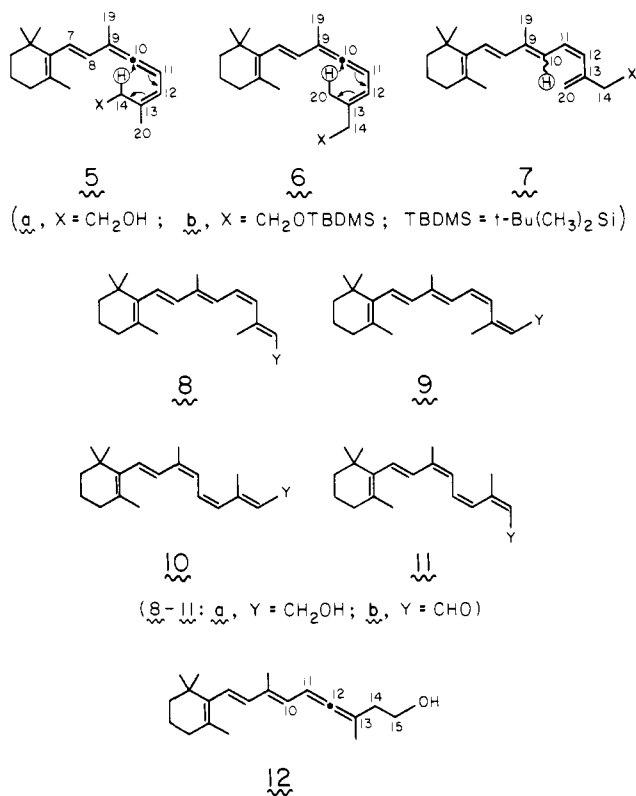

particularly attractive because only the difficult-to-obtain 11-*cis*-retinoids should obtain from the C<sub>14</sub> to C<sub>10</sub> hydrogen migration. As discussed for the general processes depicted in Scheme I, four stereoisomeric products, **8a**, **9a**, **10a**, and **11a**, are possible. A study of the corresponding Δ<sup>12</sup>-*trans* isomer **6** was also of interest. In the case of **6**, two Δ<sup>9</sup>-isomeric *retro*-retinols **7** may result. It should be noted that the 11,12-allene **12** was previously shown to undergo successive [1,5] and [1,7] sigmatropic shifts to produce the Δ<sup>9</sup>-*E* isomer of **7**.<sup>1b,d</sup> The studies therefore were expected to simultaneously provide additional information concerning what structural features effect *Z* to *E* ratios during the course of [1,5] sigmatropic shifts of vinylallenes and provide for a simple thermal route to 11-*cis*-retinoids.

The results that we wish to emphasize in this article include the preparation and thermal behavior of **5**, a more detailed description of the novel electronic and thermal properties of 9-*cis*, 11-*cis*, 13-*cis*-retinal, and a reexamination of analogous prop-

erties of 11-*cis*, 13-*cis*-retinal. A more detailed investigation of **5** revealed that it rearranges thermally to a novel fourth isomer as well as the three 11-*cis*-retinoids, **8**, **9**, and **11**, reported previously.<sup>1a</sup>

## Results and Discussion

**Vinylallene Preparation and Organocuprate Reactions.** The C<sub>5</sub> + C<sub>15</sub> coupling approach<sup>9</sup> between the propargyl benzoate **13b**

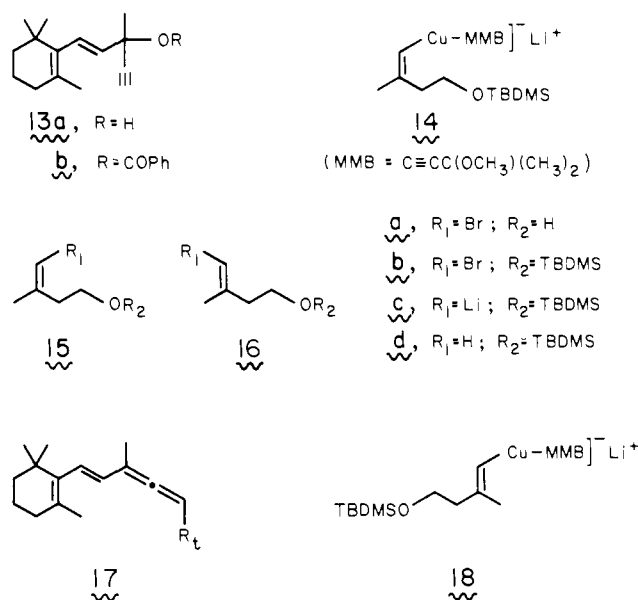

and the mixed cuprate<sup>10</sup> **14** afforded a 50% purified yield of allene silyl ether **5b**.<sup>11</sup> The latter was converted in modest yield (37%) to the alcohol **5a** by using (*n*-Bu)<sub>4</sub>NF in THF.<sup>11</sup> Alternatively, the crude product from the coupling reaction was treated with (*n*-Bu)<sub>4</sub>NF in THF and the vinylallene **5a** isolated by high-pressure LC (25% for two steps based on **15b**). Besides the characteristic IR allene stretch at 1924 cm<sup>-1</sup>, the labile allenes **5a** and **5b** exhibited appropriate <sup>1</sup>H NMR (supplementary material) and UV (247 (ε 17800) and 244 nm (ε 17000), respectively) absorptions. The C<sub>5</sub> fragment was prepared starting from isopentenyl alcohol, which was brominated (Br<sub>2</sub>/CCl<sub>4</sub>) and then dehydrobrominated (DBU, benzene) to the known<sup>12</sup> bromides **15a** and **16a** (1:2 *Z/E* mixture). Preparative high-pressure LC separation (Waters Prep 500) afforded multigram quantities of pure *Z* (**15a**) and *E* (**16a**) alcohols, which were individually converted to their *tert*-butyldimethylsilyl ethers<sup>11</sup> **15b** and **16b**, respectively. The requisite C<sub>15</sub> fragment **13b** was prepared by benzylation (*n*-butyllithium and then PhCOCl in ether, 64%)<sup>13</sup> of the known alcohol **13a**.<sup>14</sup>

The crucial coupling reaction between **13b** and various cuprate species derived from **15c** was the subject of exhaustive studies in this laboratory.<sup>2</sup> Only our best finding, using the mixed MMB-cuprate species **14** in ether, is detailed in the Experimental Section.<sup>15</sup> Besides MMB (~C≡CC(CH<sub>3</sub>)<sub>2</sub>OCH<sub>3</sub>), we have utilized numerous other nontransferring ligands in the cuprate reagent with generally less success. These include ligands derived from

(7) (a) Hammond, M. L.; Mouriño, A.; Okamura, W. H. *J. Am. Chem. Soc.* **1978**, *100*, 4907. (b) Condran, P., Jr.; Hammond, M. L.; Mouriño, A.; Okamura, W. H. *J. Am. Chem. Soc.* **1980**, *102*, 6259. (c) Mouriño, A.; Lewicka-Piekut, S.; Norman, A. W.; Okamura, W. H. *J. Org. Chem.* **1980**, *45*, 4015. (d) Condran, P., Jr.; Okamura, W. H. *J. Org. Chem.* **1980**, *45*, 4011. (e) Gerdes, J. M.; Lewicka-Piekut, S.; Condran, P., Jr.; Okamura, W. H. *J. Org. Chem.* **1981**, *46*, 5197.

(8) Besides ref 1 and 7, previous papers on the subject of sigmatropic shifts of vinylallenes include: (a) Crowley, K. J. *Proc. Chem. Soc., London* **1964**, 17. (b) Mikolajczak, K. L.; Bagby, M. O.; Bates, R. B.; Wolff, I. A. *J. Org. Chem.* **1965**, *30*, 2983. (c) Skattebøl, L. *Tetrahedron* **1969**, *25*, 4933. (d) Bakker, S. A.; Lugtenburg, J.; Havinga, E. *Recl. Trav. Chim. Pays-Bas* **1972**, *91*, 1459. (e) Havinga, E. *Experientia* **1973**, *29*, 1181. (f) van Koevinge, J. A.; Lugtenburg, J. *Recl. Trav. Chim. Pays-Bas* **1976**, *95*, 80. (g) Minter, D. E.; Fonken, G. F.; Cook, F. T. *Tetrahedron Lett.* **1979**, 711.

(9) Isler, O. "Cartenoids"; Birkhäuser Verlag: Basel, 1974. For general synthetic approaches, see pp 722-732.

(10) (a) Corey, E. J.; Floyd, D.; Lipshutz, B. H. *J. Org. Chem.* **1978**, *43*, 3418. (b) Corey, E. J.; Beames, D. J. *J. Am. Chem. Soc.* **1972**, *94*, 7210.

(11) Corey, E. J.; Venkateswarlu, A. *J. Am. Chem. Soc.* **1972**, *94*, 6190.

(12) Cornforth, J. W.; Cornforth, R. H.; Popják, G.; Yengoyan, L. *J. Biol. Chem.* **1966**, *241*, 3970. For recent reports of related substances, see: Snider, B. B.; Conn, R. S. E.; Karras, M. *Tetrahedron Lett.* **1979**, 1679. Rand, C. L.; Van Horn, D. E.; Moore, M. W.; Negishi, E. *J. Org. Chem.* **1981**, *46*, 4093.

(13) Kaiser, E. M.; Woodruff, R. A. *J. Org. Chem.* **1970**, *35*, 1198.

(14) Orosnik, W.; Mebrane, A. D. *J. Am. Chem. Soc.* **1949**, *71*, 2062.

(15) Losses suffered during purification of the labile vinylallene **5b** accounts for the modest 50% yield. The conversion to product is consistently at least 70%.

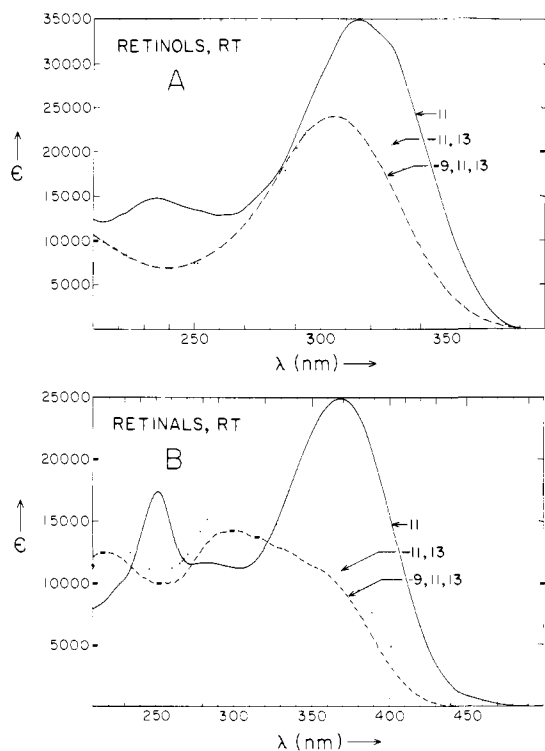

**Figure 1.** UV spectra of retinols **8a**, **9a**, and **11a** and retinals **8b**, **9b**, and **11b**. The room temperature (RT) spectra were recorded on a McPherson spectrophotometer in EPA (5:5:2 ether/isopentane/ethanol) as solvent in 10-mm quartz cells.

thiophenol, *o*- and *p*-methoxythiophenol, 2-mercaptopyridine, 1-pentyne, and also the divinylcuprate derived from **15c**.<sup>16</sup> The three thiophenols were only somewhat less effective than MMB, but the remaining three cuprate systems produced only traces (IR  $\sim 1930\text{ cm}^{-1}$ ) of vinylallene at best. As regards a study of solvent effects, the cuprate **14** prepared in ether (containing a small amount of pentane resulting from the *tert*-butyllithium reagent) was reacted with the benzoate **13b** dissolved in different solvents. The reactions performed with the benzoate dissolved in ether and hexane were comparable, but those in THF and benzene were considerably worse. The use of THF as the sole solvent, except for the small amount of pentane derived from the *tert*-butyllithium reagent, resulted in complete suppression of allene production. Because of the instability of vinylcuprates above  $-30\text{ }^\circ\text{C}$ ,<sup>16</sup> studies were limited to temperatures between  $-55$  and  $-78\text{ }^\circ\text{C}$ . However, no substantive differences in reaction efficiency were detectable in this range nor was there any advantage in increasing the reaction time from the reported 5 to 24 h. The leaving group in **13** was not investigated to any degree because the benzoate was the only leaving group to be incorporated successfully into the substrate of primary interest.<sup>17</sup>

The reaction between **13b** and other cuprates of the type ( $R_1\text{CuMMB}$ )Li were also studied under the conditions optimized for **14**. In the case of  $R_1 = \text{tert-butyl}$ , the allene **17** was obtained in 80% yield.<sup>18</sup> It should be mentioned that an invariable contaminant in the reaction between **14** and **13b** was **17** ( $R_1 = \text{tert-butyl}$ ). In order to prepare the  $\Delta^{12}$  geometric isomer of **5**,

namely **6**, analogous studies were carried out starting from the *E* bromide **16b**. However, despite *exhaustive trials*, the putative cuprate **18** derived from **16b** failed to produce **6b** when reacted with **13b**. The major identifiable product was **17** ( $R_1 = \text{tert-butyl}$ ). Studies revealed that in ether, the *E* bromide **16b** could not be lithiated cleanly under conditions (2 equiv of *tert*-butyllithium,  $-78\text{ }^\circ\text{C}$ , 4 h) that proved highly effective for the *Z* isomer **15b**. Lithiation of *E* bromide **16b** does proceed cleanly in THF, but as noted for the corresponding *Z* isomer, coupling of the vinylcuprate with benzoate **13b** in THF failed to produce vinylallene **6**.

**Thermal Experiments.** The vinylallene silyl ether **5b** was refluxed for 2 h in hexane ( $\sim 69\text{ }^\circ\text{C}$ ,  $10^{-3}\text{ M}$ ,  $\text{N}_2$ ), deprotected (*n*-Bu<sub>4</sub>NF, THF), and then subjected to high-pressure LC to yield in the following order of elution 11-*cis*,13-*cis*-retinol (**9a**, 11.5%), 9-*cis*,11-*cis*,13-*cis*-retinol (**11a**, 14%), and 11-*cis*-retinol (**8a**, 10%) (35.5% combined yield based on **5b**). The corresponding alcohol **5a** when thermolyzed under identical conditions followed by LC separation afforded the same three isomeric retinols in 15.2%, 14.4%, and 13.7% yields, respectively. These three isomers were the only detectable retinols, and each of them was separately shown to be completely stable to the reaction conditions.

The absence of the fourth possible geometric isomer, 9-*cis*,11-*cis*-retinol (**10a**), as a product of the thermolysis reaction was puzzling.<sup>19</sup> However, the formation of the cyclized compound **19** as a product in the thermal rearrangement of the vinylallene

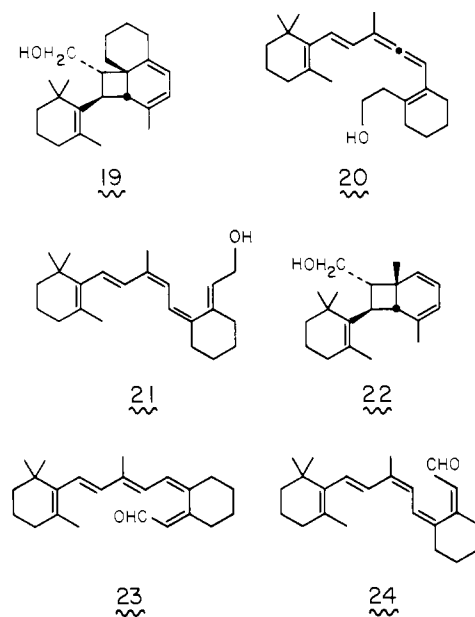

**20**, presumably via the intermediacy of the 9-*cis*,11-*cis* isomer **21**,<sup>16</sup> prompted us to reexamine rigorously the thermal rearrangement of **5a**. Indeed, a cyclized compound **22** of exceptionally low LC retention time has now been identified as a product (13.9% yield) of the thermal rearrangement. The 9-*cis*,11-*cis*-retinol (**10a**) possesses in it a *trans,cis,cis,trans*-tetraene moiety. Tetraenes of this type are known to undergo extremely facile eight-electron conrotatory electrocyclicization to cycloocta-1,3,5-trienes followed by six-electron disrotatory electrocyclicization to bicyclo[4.2.0]octa-2,4-dienes.<sup>20</sup> Such a series of electrocyclicizations would result in the rearrangement of the putative 9-*cis*,11-*cis* isomer **10a** to **22**.

In terms of the competing processes depicted in Scheme I, the products observed in the rearrangement of **5a** correspond to a  $\sim 1:1:1:1$  ratio of paths A:B:C:D, wherein the products **1b**, **2b**, **3b**, and **4b** correspond to 11-*cis*- (**8a**), the putative 9-*cis*,11-*cis*- (**10a**) (which further electrocyclicizes to **22**), 11-*cis*,13-*cis*- (**9a**),

(16) (a) Posner, G. *Org. React. (N.Y.)* **1972**, *19*, 1. (b) Posner, G. *Ibid.* **1975**, *22*, 253. (c) Posner, G. "An Introduction to Synthesis Using Organocopper Reagents"; Wiley: New York, 1980. (d) Jukes, A. *Adv. Organomet. Chem.* **1973**, *12*, 215 and references cited therein.

(17) Unsuccessful attempts to convert **13a** to its bromide or methanesulfonate have been reported: Amos, R. A.; Katzenellenbogen, J. A. *J. Org. Chem.* **1978**, *43*, 555.

(18) The analogous MMB-cuprates obtained from methylolithium and *n*-butyllithium were also reacted with **13b**. The methylcuprate afforded a 4:1 ratio of **17** ( $R_1 = \text{CH}_3$ ) and reduction product **17** ( $R_1 = \text{H}$ ). The *n*-butylcuprate afforded a 9:1 ratio of **17** ( $R_1 = n\text{-Bu}$ ) and **17** ( $R_1 = \text{H}$ ). No reduction products were detected (<sup>1</sup>H NMR) in the *tert*-butyl case under identical conditions (see Experimental Section).

(19) For recent studies of 9-*cis*,11-*cis*-retinoids, see: Kini, A.; Matsumoto, H.; Liu, R. S. H. *Biorg. Chem.* **1980**, *9*, 406.

(20) (a) Marvell, E. N.; Seubert, J. *J. Am. Chem. Soc.* **1967**, *89*, 337. (b) Huisgen, R.; Dahmen, A.; Huber, H. *Ibid.* **1967**, *89*, 7130.

and 9-*cis*,11-*cis*,13-*cis*-retinols (**11a**), respectively. Thus, the thermal rearrangement of the 9,10-allene **5**, though specific for the formation of 11-*cis*-retinoids, exhibits no selectivity in the formation of the lateral double bonds  $\Delta^9$  and  $\Delta^{13}$ , and, moreover, the 9-*cis*,11-*cis* isomer is unstable to the conditions of reaction. The method, however, does provide direct access to three of the otherwise difficult-to-obtain 11-*cis* isomers in sufficient quantities for investigation.

The highly hindered retinals, 11-*cis*,13-*cis* (**9b**) and 9-*cis*,11-*cis*,13-*cis* (**11b**), were found to be quite unstable thermally. On mild warming ( $\sim 40^\circ\text{C}$ ,  $\text{CDCl}_3$ ,  $t_{1/2} \sim 2$  h) **9b** and **11b** isomerized cleanly to 13-*cis*-retinal and 9-*cis*,13-*cis*-retinal, respectively, presumably via successive electrocyclic ring-closing and ring-opening processes.<sup>21</sup>

**Spectral Properties.** Figure 1 compares the electronic absorption spectra of the 11-*cis*-, 11-*cis*,13-*cis*-, and 9-*cis*,11-*cis*,13-*cis*-retinols and retinals. The electronic absorption spectrum of 9-*cis*,11-*cis*,13-*cis*-retinal (**11b**) is remarkable in that its main maximum at 302 nm (95% EtOH,  $\epsilon$  14 300) is actually to the blue of the corresponding alcohol, **11a** [ $\lambda_{\text{max}}$  (95% EtOH) 306 nm ( $\epsilon$  24 500)]. Since all the other known retinals exhibit their maxima in the region of 360 nm,<sup>22</sup> the maximum exhibited by **11b** is indicative of a highly twisted chromophore. Examination of models indicate that 11-*cis*,13-*cis*-retinal (**9b**) and the tricis isomer, **11b**, exhibit similar steric interactions and that the two isomers should be distorted in a similar fashion. We therefore proceeded to reexamine<sup>23</sup> the absorption spectrum of 11-*cis*,13-*cis*-retinal (**9b**), exercising due care to prevent its thermal isomerization to 13-*cis*-retinal, and indeed, **9b** was also found to exhibit its main maximum at 302 nm (95% EtOH,  $\epsilon$  17 000).

The two major bands of the absorption spectra of retinals have been assigned as follows:  $\lambda_g \sim 360$  nm ( $^1\text{B}_u^{*+}$  and  $^1\text{A}_g^{*-}$ ),<sup>24a</sup>  $\lambda_g \sim 280$  nm ( $^1\text{A}_g^{*+}$ ).<sup>24b</sup> In general, retinals exhibit intense  $\alpha$  bands and relatively weak  $\beta$  bands.<sup>3</sup> In **9b** and **11b** this order is reversed, the  $\beta$  bands being more intense than the  $\alpha$  bands. Extreme examples of this situation can be found in the 12-*s-cis* locked 11-*cis*,13-*cis*- and 9-*cis*,11-*cis*,13-*cis*-retinal analogues, **23** and **24**.<sup>1c</sup> However, the corresponding 12-*s-trans*-locked analogues synthesized by Nakanishi and co-workers<sup>25</sup> exhibit normal spectra with prominent  $\alpha$  bands. The data suggest that **9b** and **11b** exist predominantly in a twisted 12-*s-cis* conformation and that the appearance of prominent  $\beta$  bands is characteristic of this conformer.<sup>26</sup>

## Experimental Section

**General.** Spectroscopic ( $^1\text{H}$  NMR, IR, UV, and high- and low-resolution MS) and other analytical data are given in the supplementary material. Air-sensitive materials were generally stored under nitrogen in a  $-80^\circ\text{C}$  freezer, and reactions involving organometallic materials were performed under an atmosphere of dry nitrogen. References to aqueous  $\text{NaHCO}_3$ ,  $\text{NH}_4\text{Cl}$ , or  $\text{NaCl}$  during experimental workup procedures refer to saturated aqueous solutions unless otherwise stated. Dry ether or THF (tetrahydrofuran) refers to reagent grade material freshly distilled from benzophenone ketyl or  $\text{LiAlH}_4$  under nitrogen. Skellysolve B, hexanes, and lbpe (low boiling petroleum ether, bp  $30\text{--}60^\circ\text{C}$ ) were distilled from  $\text{CaH}_2$  prior to use. Pyridine was distilled from  $\text{CaH}_2$  or KOH and stored over 4- $\text{\AA}$  molecular sieves. Kugelrohr distillation boiling

points (bp) refer to the external air bath temperature. Melting points (mp) (uncorrected) were obtained on a Thomas-Hoover capillary apparatus.

High-pressure liquid chromatography (high-pressure LC) was performed by using a Waters 6000A solvent delivery system equipped with a U6K injector and dual detector system (M450 variable wavelength UV and R401 refractive index detectors). A Whatman M9 10/50 Partisil (10- $\mu\text{m}$  particle size, 9.4 mm i.d.  $\times$  50 cm) column was used for normal phase conditions unless otherwise noted. All chromatography solvents were distilled prior to use. Solvents and solvent mixtures were vacuum filtered through a 0.45- $\mu\text{m}$  Millipore filter and vacuum degassed immediately prior to use. Medium-pressure LC refers to a system designed by Meyers and co-workers.<sup>27</sup> Columns used were 1000  $\times$  15 mm ( $< 2$  g of material) and 1000  $\times$  25 mm ( $> 2$  g of material). A Waters Prep 500 LC using silica cartridges was also utilized for multigram scale separations. Silica gel 60 (230-300 mesh) obtained from MCB-Merck was used in the medium-pressure LC. Ordinary column chromatography was performed by using J. T. Baker silica gel (60-200 mesh). Thin layer chromatography (TLC) was performed by using either EM Laboratories silica gel G (0.4 mm thickness analytical plates) or precoated plates using silica gel 60 F-254 from MCB-Merck.

**9-Ethynyl- $\beta$ -ionol (13a).**<sup>14</sup> Lithium acetylide-ethylenediamine complex (37.5 g, 0.407 mol) was weighed quickly into a 500-mL flask equipped with a stirring bar, dropping funnel, and drying tube. The flask was charged with 100 mL of dry THF, and then  $\beta$ -ionone (40 g, 0.208 mol) in 125 mL of dry THF was added dropwise to the stirred suspension. Stirring was continued for  $\sim 20$  h and then the reaction was quenched by the addition of 1 N HCl ( $\sim 150$  mL), until the mixture was free flowing and no further effervescence was observed. The reaction mixture was poured into a separatory funnel, extracted with 500 mL of ether, and washed successively with 250 mL of saturated  $\text{NaHCO}_3$  solution and water. After drying with  $\text{MgSO}_4$ , the ether was removed on the rotary evaporator. The resulting yellow oil was distilled on the Kugelrohr ( $96^\circ\text{C}$ , 0.23 mm) to yield the pure alcohol **13a** (42.5 g, 94%).

**9-Ethynyl- $\beta$ -ionol Benzoate (13b).** To a stirred solution of 9-ethynyl- $\beta$ -ionol (**13a**) (10.0 g, 45.8 mmol) in 87.5 mL of dry ether at a  $-10^\circ\text{C}$  under nitrogen was added dropwise 30.7 mL of 1.6 M *n*-butyllithium (45.8 mmol). After the resulting solution was stirred 20 min, benzoyl chloride (5.31 mL, 45.8 mmol) was added quickly and the stirred solution was then allowed to warm to room temperature (1.5 h) followed by an additional 1.5 h of stirring at room temperature.<sup>13</sup> The resulting yellow suspension was then poured into 100 mL of brine and extracted with an additional 100 mL of ether. The yellow ether layer was dried with  $\text{MgSO}_4$  and concentrated on the rotary evaporator followed by evacuation, with occasional vigorous shaking, under high vacuum for about 5 min. Five milliliters of pentane was added along with a seed crystal and the solution placed in the freezer overnight. The crystals were collected via vacuum filtration on a sintered glass funnel. They were crushed with a spatula and washed quickly with pentane cooled to  $-78^\circ\text{C}$ . Any remaining dark yellow clumps were crushed and washed again with cold pentane. The resulting light yellow crystals were dried in vacuo for about 20 min to yield 9.45 g (64%) of the ester **13b**, mp  $52\text{--}53^\circ\text{C}$ .

**(Z)- (15a) and (E)-4-Bromo-3-methyl-3-buten-1-ol (16a).**<sup>12</sup> Isopentenyl alcohol (10 g, 0.12 mol) was added to  $\text{CCl}_4$  (40 mL) in a 200-mL round-bottomed flask equipped with a magnetic stirring bar and dropping funnel with drying tube. Sodium bicarbonate (0.1 g) was added, the solution was cooled to  $0^\circ\text{C}$  with an ice bath, and then a solution of bromine (6 mL, 0.12 mol; in 14 mL  $\text{CCl}_4$ ) was added slowly via the dropping funnel with constant stirring of the solution. Addition was continued until no further discoloration of the bromine solution was observed. After 1 h, the product was worked up by washing with 40 mL of a saturated  $\text{Na}_2\text{S}_2\text{O}_3$  solution followed by 40 mL of water, drying with  $\text{MgSO}_4$ , and evaporating the solvent on a rotary evaporator. The crude dibromide (27 g, 94%) was pure by NMR and TLC (40% ether/lbpe, silica gel).

The crude dibromide (27 g, 0.11 mol) was dissolved in benzene (46 mL) in a three-necked 200-mL flask equipped with a dropping funnel, reflux condenser, and stopper. Diazabicycloundecene (DBU, 18.4 g, 0.12 mol) was added dropwise to the stirred solution. The reaction was mildly exothermic, and the resulting golden solution, which became cloudy with time, was allowed to stir for 4 h. Ether was added to the room temperature reaction mixture and the liquid was decanted from the solid into a separatory funnel. The remaining solid was washed several times with ether and the combined ethereal washings and extract were washed twice successively with 1 N HCl, saturated  $\text{NaHCO}_3$ , and water. The organic layer was dried with  $\text{Na}_2\text{SO}_4$  and the ether removed on the rotary evaporator to leave the crude vinyl bromides. Kugelrohr distillation (bp  $80^\circ\text{C}$  (1 mm)) afforded the pure mixture of vinyl bromides **15a** and **16a** (9 g, 49%; 47% based on isopentenyl alcohol) in a 1:2 ratio as determined by gas chromatography (Varian 3700, 5% OV-17,  $10 \times 1/8$  in.,  $130^\circ\text{C}$

(21) Kini, A.; Matsumoto, H.; Liu, R. S. H. *J. Am. Chem. Soc.* **1979**, *101*, 5078. For additional examples of isomerization of *cis,cis*-dienones, see the references to Schiess and co-workers and Lillya and co-worker as reviewed by: Marvell, E. N. "Thermal Electrocyclic Reactions"; Academic Press: New York, 1980; pp 315-316.

(22) Liu, R. S. H. Proceedings of the 6th International Symposium on Carotenoids, Liverpool, July 1981.

(23) A  $\lambda_{\text{max}}$  of 373 nm has been reported for **9b** (Hubbard, R.; Wald, G. *J. Gen. Physiol.* **1952**, *36*, 269). However, given the ready thermal isomerization of **9b** to 13-*cis*-retinal, it is likely that the previous workers were actually observing the spectrum of 13-*cis*-retinal.

(24) (a) Birge, R. R.; Bennett, J. A.; Hubbard, L. M.; Fang, H. L.; Pierce, B. M.; Klinger, D. S.; Leroy, G. E. *J. Am. Chem. Soc.* **1982**, *104*, 2519. (b) Honig, B.; Dinur, U.; Birge, R. R.; Ebrey, T. G. *Ibid.* **1980**, *102*, 488.

(25) Akita, H.; Tanis, S. P.; Adams, M.; Balogh-Nair, V.; Nakanishi, K. *J. Am. Chem. Soc.* **1980**, *102*, 6370.

(26) An alternative rationale for the unusually blue-shifted maximum observed for **11b** is given in footnote 17 of ref la.

column temperature, 20 mL/min flow rate). High-pressure LC separation (Waters Prep 500, two silica cartridges; 10% isopropyl alcohol in hexanes) using the shave-recycle technique afforded microgram quantities of pure geometric isomers. The *Z* isomer eluted first. Medium-pressure LC (100 × 2.5 cm; 50% ether/lbpe) was also effective for separating smaller quantities of isomers.<sup>27</sup>

**(Z)-4-Bromo-3-methyl-1-(tert-butylidimethylsilyloxy)but-3-ene (15b).** Imidazole (4.0 g, 59 mmol) and *tert*-butyldimethylsilyl chloride (4.4 g, 29 mmol) were added under nitrogen to dimethylformamide (19.2 mL) in a 50-mL round-bottomed flask, and the resulting mixture was stirred until homogeneous. The (*Z*)-vinyl bromide **15a** (3.2 g, 19.4 mmol) was added followed by a small (~1 mL) wash with dimethylformamide, and the resulting solution was stirred for 5.5 h. The reaction mixture was worked up by pouring into 50 mL of 1 N HCl, extracting with 100 mL of ether, washing with 50 mL of saturated NaHCO<sub>3</sub> and then water, and drying with MgSO<sub>4</sub>. The solvent was removed on a rotary evaporator. Kugelrohr distillation (80 °C, 0.7 mm) gave the product as a clear colorless liquid (5.1 g, 94%).

**(E)-4-Bromo-3-methyl-1-(tert-butylidimethylsilyloxy)but-3-ene (16b).** The *E* alcohol **16a** was converted to its *tert*-butyldimethylsilyl ether, **16b**, exactly as described in the preceding experiment: 96% yield from *E* alcohol (16.6 g, 0.101 mol), imidazole (21.4 g, 0.314 mol), *tert*-butyldimethylsilyl chloride (22.2 g, 0.147 mol), and dimethylformamide (100 mL); Kugelrohr bp 80 °C (0.7 mm).

**10,14-retro-Retinyll tert-Butyldimethylsilyl Ether (5b).** The *Z* bromide **15b** (0.525 g, 1.88 mmol) was placed in a 1.5 × 15 cm test tube equipped with a stir bar. The tube was flushed with dry nitrogen, stoppered, equipped with a nitrogen inlet, charged with 3.8 mL of dry ether, and cooled to -78 °C with a dry ice bath. A solution of *tert*-butyllithium in pentane (2.45 mL, 3.8 mmol, 1.54 M) was added slowly dropwise via syringe and then stirred for 4 h. A suspension of copper 3-methoxy-3-methylbutyne (CuMMB; prepared as described in the next paragraph) was added dropwise via cannula, and the resulting yellow suspension was allowed to stir for 0.3 h. The benzoate **13b** (600 mg, 1.88 mmol) in 3.8 mL of dry ether was introduced dropwise, and the resulting solution was allowed to stir for 5 h at -78 °C, followed by slow warming to room temperature (0.5 h) and then quenching with a small amount of water (0.5 mL). Solids were removed by vacuum filtration through Celite, and the filtrate was concentrated on the rotary evaporator. Filtration through a short column of silica (2% pyridine/lbpe) afforded 500 mg of crude product contaminated by small amounts of **15d** (**16d**) and **17** (R = *tert*-butyl). Medium-pressure LC (2% pyridine in lbpe as eluant) gave 375 mg (50%) of the allene **5b**.

For the preparation of CuMMB,<sup>10</sup> 2-methoxy-2-methylbut-3-yne (0.275 g, 2.8 mmol) was weighed into a test tube equipped with a stir bar and a stopper, and 3.25 mL of dry ether was added under nitrogen. The solution was cooled to -8 °C by means of an ice-acetone bath, and then 1.75 mL of 1.6 M *n*-butyllithium was added via syringe. The resulting suspension was stirred for 0.6 h, at which point 4 mL was removed by syringe and quickly added to a stirred suspension of cuprous iodide (4.8 mg, 2.19 mmol; previously purified by Soxhlet THF extraction) in 3.6 mL of dry ether. This suspension, initially almost white, was allowed to stir at least 15 min, during which time the suspension became a deep yellow-orange. The solution should be used shortly after it is prepared.

**10,14-retro-Retinol (5a).** To the crude vinylallene silyl ether **5b** (obtained from a 0.8 mmol scale coupling reaction and purified only by filtration through a short column of silica gel) in a 10-mL round-bottom flask, equipped with a Teflon stir bar, under nitrogen at room temperature was added via syringe 3.5 mL of a 1 M solution of tetra-*n*-butylammonium fluoride in dry THF. The solution was stirred for 3 h, poured into 30 mL of saturated brine, and extracted three times with 30 mL of ether. The combined ether extracts were washed with 15 mL of saturated NaHCO<sub>3</sub> solution and 15 mL of saturated brine, dried over MgSO<sub>4</sub>, and concentrated in vacuo. The residue was filtered through a short silica gel column (2% pyridine/30% ether/lbpe as eluant). After removal of solvent in vacuo, pure **5a** (57 mg; 25% yield for coupling and deprotection steps based on **15b**) was isolated by high-pressure LC (Partisil, 15% ethyl acetate in Skellysolve B, 4 mL/min flow rate). In an alternative experiment medium-pressure LC purified vinylallene silyl ether **5b** was deprotected by the same procedure to give **5a** in 37% yield.

**1-(3-Methyl-6,6-dimethylhepta-1,3,4-trienyl)-2-methyl-6,6-dimethylcyclohexene (17, R = *tert*-Butyl).** *tert*-Butyllithium (0.61 mL, 1.54 M in pentane, 0.93 mmol) was added to 1.8 mL of dry ether at -78 °C under N<sub>2</sub>. A solution of CuMMB (3.8 mL of a suspension prepared as described under the Experimental Section for the preparation of 10,14-retro-retinyll silyl ether **5b**) was added and the suspension stirred for 20

min. The benzoate **13b** (300 mg, 0.93 mmol) in 1.8 mL of dry ether was added and the stirring at -78 °C continued for 5 h. The reaction mixture was warmed to room temperature and then quenched with water. The reaction mixture was poured into water, extracted with ether, and dried with MgSO<sub>4</sub> and the solvent removed on the rotary evaporator. The product was chromatographed (silica, lbpe) to yield 210 mg (80%) of the *tert*-butyl allene **17** (R = *tert*-butyl).

**Thermolysis and Then Deprotection of 10,14-retro-Retinyll tert-Butyldimethylsilyl Ether (5b).** **11-cis-** (**8a**), **11-cis,13-cis-** (**9a**), and **9-cis,11-cis,13-cis-Retinol (11a)**. The vinylallene silyl ether **5b** (388 mg, 0.97 mmol) under nitrogen in 100 mL of hexanes was added to 900 mL of hexanes preheated to reflux. After heating the mixture for 2 h, the solvent was immediately removed on the rotary evaporator. The residue was placed in a 10-mL round-bottomed flask with stirring bar and purged with nitrogen. A solution of tetra-*n*-butylammonium fluoride (5 mL, 1 M solution in THF) was added and the solution stirred for 1 h (or until no further reaction was detected by TLC). The reaction mixture was poured into 50 mL of brine and extracted with 100 mL of lbpe. The organic layer was dried with MgSO<sub>4</sub> and the solvent removed on the rotary evaporator. Subjection of the product to a short column chromatographic filtration followed by separation of the isomers by high-pressure LC as above afforded the following three isomers: **11-cis,13-cis-** (**9a**) (31.4 mg, 11.5%), **9-cis,11-cis,13-cis-** (**11a**) (38.5 mg, 14%), and **11-cis-** (**8a**) (27.8 mg, 10%) free from impurities (35.5% total yield of the three isomers based on silyl ether **5b**).

*all-trans*-Retinol, *9-cis*-retinol, **11-cis-retinol (8a)**, *13-cis*-retinol, **11-cis,13-cis-retinol (9a)**, and *9-cis,13-cis-retinol* were available for direct spectral (<sup>1</sup>H NMR) and/or chromatographic comparisons. This allowed positive identification of **8a** and **9a** as two of the products of the thermal rearrangement while specifically ruling out *all-trans-*, *9-cis-*, *13-cis-*, and *9-cis,13-cis*-retinols as the third and remaining isomer. Oxidation (MnO<sub>2</sub>) of **8a** and **9a** afforded the retinals **8b** and **9b** (see below), which were also identical with authentic specimens. By contrast, oxidation of the third isomer (see below) afforded what has been identified as the *cis,cis,cis* isomer **11b** on the basis that its <sup>1</sup>H NMR spectrum was characteristically different from that of the only other reasonable isomer, namely *9-cis,11-cis-retinal (10b)*.

**Thermolysis of 10,14-retro-Retinol (5a): 11-cis-** (**8a**), **11-cis,13-cis-** (**9a**), and **9-cis,11-cis,13-cis-Retinol (11a)** and **1,5-Dimethyl-7-(2,6,6-trimethylcyclohex-1-enyl)-8-hydroxymethylbicyclo[4.2.0]octane (22)**. To 220 mL of hexanes (freshly distilled from LiAlH<sub>4</sub> and deaerated by bubbling nitrogen through it with stirring) heated to reflux under nitrogen was added via a syringe a solution of vinylallene alcohol **5a** (57 mg, 0.199 mmol) in 20 mL of hexanes (purified as above). The solution was heated for 2 h and cooled and solvent removed in vacuo. The residue was subjected to purification by high-pressure LC (Partisil, 15% ethyl acetate in Skellysolve B, 4 mL/min flow rate) to yield in order of elution the following: **22** (7.9 mg, 14%), **9a** (8.7 mg, 15%), **11a** (8.2 mg, 14%), and **8a** (7.8 mg, 14%). The total yield of the four products was 57% from the vinylallene alcohol **5a**.

**9-cis,11-cis,13-cis-** (**11b**), **11-cis,13-cis-** (**9b**), and **11-cis-Retinal (8b)**. The *cis,cis,cis* alcohol **11a** (20.8 mg, 0.073 mmol) was dissolved in 2 mL of lbpe at 4 °C (cold room temperature) in a 10-mL round-bottom flask (covered in tin foil to protect the reaction mixture from light) equipped with a stir bar and stopper. Activated MnO<sub>2</sub> (200 mg, 2.3 mmol) was added, and the resulting suspension was stirred for 1 h. The MnO<sub>2</sub> was removed by vacuum filtration through Celite and the collected MnO<sub>2</sub> was washed with ether. The resulting solution was evaporated to dryness on the rotary evaporator (<room temperature) and purified by high-pressure LC (Partisil, 5% ethyl acetate, Skellysolve B, 4 mL/min flow rate) to give 17.0 mg (82% yield) of **11b**.

The oxidation of the *11-cis-* (**8a**) and *11-cis,13-cis*-retinols (**9a**) to the known aldehydes (**8b** and **9b**, respectively) was carried out in a similar fashion, and yields were also about 80% in each case. The electronic spectral data reported (see Figure 2 and the supplementary material) in this paper were reproducible for at least three samples whose purity was ascertained by <sup>1</sup>H NMR analysis.

**Individual Thermolysis of 11-cis-** (**8a**), **11-cis,13-cis-** (**9a**), and **9-cis,11-cis,13-cis-Retinol (11a)**. A solution of the retinol (3.5 mg/mL) in nitrogen-purged Skellysolve B was prepared. A 2-mL aliquot of this solution was added to 25 mL of nitrogen-purged Skellysolve B heated to reflux under N<sub>2</sub> in a three-necked flask equipped with stopper, condenser, and stopcock inlet. Aliquots were then withdrawn at various intervals and stored in the freezer until analyzed by high-pressure LC (3% isobutyl alcohol in Skellysolve B) using the UV detector. The qualitative observations were as follows. At reaction times of 5 h and less, there is no change in the elution profiles of the retinols. At longer thermolysis times (>20 h), several minor peaks are detectable. These are unidentified nonpolar compounds. The important essential conclusion is that there is no evidence for interconversion of any of the three isomers nor isom-

(27) Meyers, A. I.; Slade, J.; Smith, R. K.; Mihelich, E. D.; Hershenson, F. M.; Liang, C. D. *J. Org. Chem.* **1979**, *44*, 2247.

erization to other retinol isomers at least during the first 5 h and also apparently to near 20 h.

**Thermolysis of 11-*cis*,13-*cis*- (9b) and 9-*cis*,11-*cis*,13-*cis*-Retinal (11b).** The retinal (10–15 mg) was dissolved in CDCl<sub>3</sub> in an NMR tube and placed in the NMR probe heated to 40 °C (±3 °C). The reaction progress was followed by measuring the peak heights of the starting and product retinal aldehyde signal (near δ 10). On the basis of inspection of the NMR spectra, the 9-*cis*,11-*cis*,13-*cis* isomer **11b** isomerizes cleanly to the 9-*cis*,13-*cis*-retinal, and the 11-*cis*,13-*cis* isomer **9b** to 13-*cis*-retinal. First-order rate plots of the data obtained reveal straight lines with half-lives for both reactions of ~2.3 h.

**Acknowledgment.** The U.S. Public Health Service (NIH Grants EY-02452 and EY-02202 and, in part, NCI Contract N01-CP-05715), the University of California Cancer Research Coordinating Committee (Grant 79R4), and the Intramural Research Fund, University of California, Riverside, provided financial support for this project. Authentic specimens or precursors to authentic specimens of various retinoids used for spectral and/or

chromatographic comparisons were made available by Dr. Gary Olson and Dr. David Coffen of the Hoffmann-LaRoche Co. (Nutley, NJ). Chemicals were also provided by Badische-Anilin Und Soda-Fabrik, A.G. (Ludwigshafen). Spectral data for 9-*cis*,11-*cis*-retinal was kindly provided to us prior to publication by Professor Robert S.H. Liu.

**Registry No.** **5a**, 74792-67-9; **5b**, 74722-99-9; **8a**, 22737-96-8; **8b**, 564-87-4; **9a**, 17706-49-9; **9b**, 564-88-5; **11a**, 74743-94-5; **11b**, 67737-36-4; **13a**, 17974-59-3; **13b**, 74723-00-5; **15a**, 74723-01-6; **15b**, 84303-93-5; **15d**, 74915-94-9; **16a**, 74723-02-7; **16b**, 84303-94-6; **16d**, 74915-94-9; **17** (R<sub>1</sub> = *tert*-butyl), 84303-95-7; **22**, 84303-96-8; β-ionone, 79-77-6; isopentenyl alcohol, 763-32-6; 3,4-dibromo-3-methylbutanol, 10518-50-0; 2-methoxy-2-methylbut-3-yne, 13994-57-5; 13-*cis*-retinal, 472-86-6; CuMMB, 66769-63-9.

**Supplementary Material Available:** Spectral and analytical data (10 pages). Ordering information is given on any current masthead page.

## A Cyclic Phosphate: Base and Metal Acetate Catalyzed Ring Opening

William G. Wadsworth and William S. Wadsworth, Jr.\*

Contribution from the Department of Chemistry, South Dakota State University, Brookings, South Dakota 57007. Received August 13, 1982

**Abstract:** Six-membered ring phosphates in which a good leaving group is absent undergo methanolysis to give acyclic products that can reclose to the original cyclic system. Under basic conditions the sequence is not stereospecific, which is explained by assuming an indiscriminant attack by alkoxide ion at more than one face of the tetrahedral phosphate. A ring opening-closing-opening sequence is described. Lead(II) acetate, as its hydrate, is unique in its ability to catalyze ring opening and closure. The sequence, unlike base catalysis, is stereospecific and yields only that isomer expected if attack occurs axially to give an oxyphosphorane intermediate in which the ring spans axial-equatorial positions.

The 2-substituted-5-(chloromethyl)-5-methyl-2-oxo-1,3,2-dioxaphosphorinane system

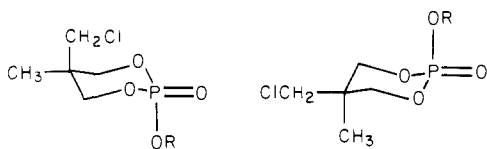

has proven to be most valuable in allowing us to determine the stereochemistry of substitution reactions. *Cis* and *trans* isomers can easily be distinguished one from the other by simple NMR measurements. The rings are conformationally immobile with the result that the methyl hydrogens have different chemical shifts as do those of the chloromethyl group. With this tool the course of substitutions at the phosphorus atom has been determined with ease.<sup>1,2</sup>

In a series of papers we have attempted to outline those factors which give rise to either retention or inversion at the phosphorus atom.<sup>3-5</sup> In summary, we find that back-bonding between attacking nucleophile and the phosphorus atom is of prime im-

portance. Efficient back-bonding which leads to retention is enhanced by factors which increase the positive character at the phosphorus atom such as electron-withdrawing ligands or by Lewis acids which bond to the basic phosphoryl oxygen. In contrast, inversion is favored by nucleophiles which are poor back-bonders and by leaving groups weakly bonded to phosphorus.

Retention is commonly pictured as proceeding via a trigonal-bipyramidal intermediate or transition state whereas inversion is depicted as a direct S<sub>N</sub>2 displacement.

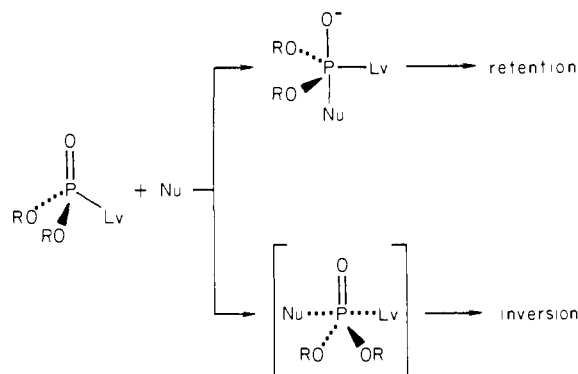

More recently, we have concentrated upon alcoholysis of esters and have found, in accordance with the above, that alkoxide ions substitute in all cases by complete retention; a high degree of back-bonding between nucleophile and phosphorus atom exists

(1) Wadsworth, W. S., Jr., Larsen, S.; Horten, H. L. *J. Org. Chem.* **1973**, *38*, 256.

(2) Wadsworth, W. S., Jr. *J. Org. Chem.* **1973**, *38*, 2921.

(3) Wadsworth, W. S., Jr.; Wilde, R. L. *J. Org. Chem.* **1976**, *41*, 1264.

(4) Bauman, M.; Wadsworth, W. S., Jr. *J. Am. Chem. Soc.* **1978**, *100*, 6388.

(5) Gehrke, S. H.; Wadsworth, W. S., Jr. *J. Org. Chem.* **1980**, *45*, 3921.